

Myhill-Nerode Theorem

Deepak D'Souza

Department of Computer Science and Automation
Indian Institute of Science, Bangalore.

1 September 2015

Outline

- 1 Overview
- 2 Myhill-Nerode Theorem
- 3 Correspondence between DA's and MN relations
- 4 Canonical DA for L
- 5 Computing canonical DFA

Myhill-Nerode Theorem: Overview

- Every language L has a “canonical” deterministic automaton accepting it.
 - Every other DA for L is a “refinement” of this canonical DA.
 - There is a unique DA for L with the minimal number of states.
- Holds for **any** L (not just regular L).
- L is regular iff this canonical DA has a finite number of states.
- There is an algorithm to compute this canonical DA from any given finite-state DA for L .

Illustrating “refinement” of DA: Example 0

- Replicate each state in the first automaton some number of times, and add an edge labelled a from p_i (a copy of state p) to q_j provided $\delta(p, a) = q$. Then “split” DFA accepts the same language.
- Conversely, every DA for L is a “splitting” of the canonical DA for L .

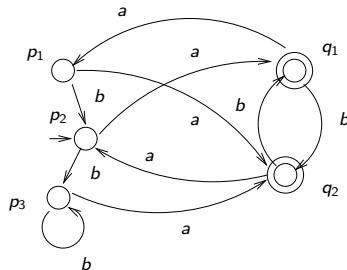
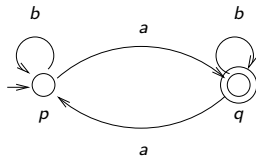

Illustrating "refinement" of DA: Example 1

Every DA for L is a "refinement" of this canonical DA:

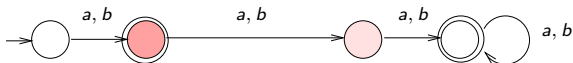
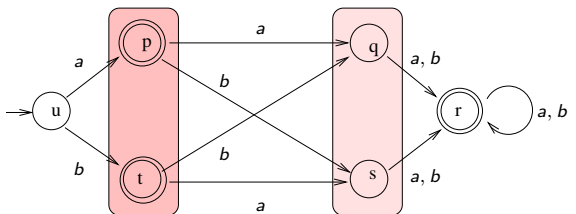

Illustrating “refinement” of DA: Example 2

Every DA for L is a “refinement” of this canonical DA:

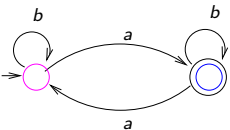
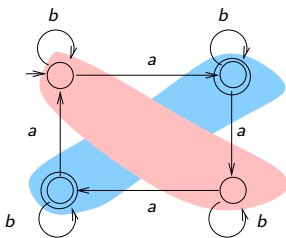

Myhill-Nerode Theorem

Canonical equivalence relation \equiv_L on A^* induced by $L \subseteq A^*$:

$$x \equiv_L y \text{ iff } \forall z \in A^*, xz \in L \text{ iff } yz \in L.$$

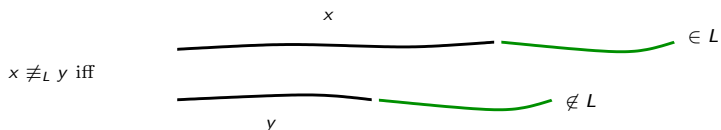

Theorem (Myhill-Nerode)

L is regular iff \equiv_L is of finite index (that is has a finite number of equivalence classes).

Exercise 1

Describe the equivalence classes for $L =$ “Odd number of a 's”.

Exercise 2

Describe precisely the equivalence classes of \equiv_L for the language $L \subseteq \{a, b\}^*$ comprising strings in which the 2nd last letter is a b .

Exercise 2

Describe precisely the equivalence classes of \equiv_L for the language $L \subseteq \{a, b\}^*$ comprising strings in which the 2nd last letter is a b .

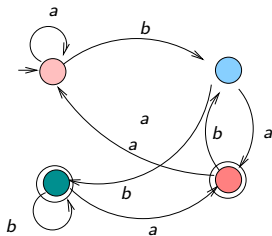

$\epsilon, a, . * aa$	$b, . * ab$
$. * bb$	$. * ba$

Exercise 3

Describe the equivalence classes of \equiv_L for the language $L = \{a^n b^n \mid n \geq 0\}$.

Exercise 3

Describe the equivalence classes of \equiv_L for the language $L = \{a^n b^n \mid n \geq 0\}$.

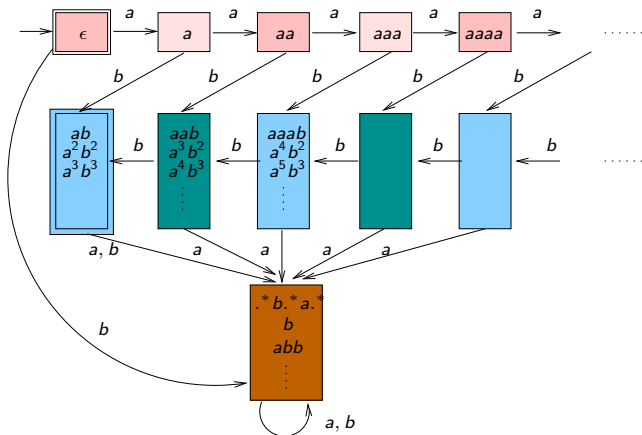

Exercise 3

Describe the equivalence classes of \equiv_L for the language $L = \{a^n b^n \mid n \geq 0\}$.

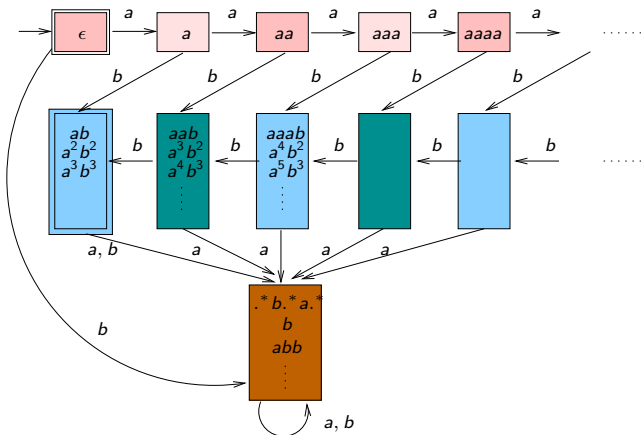

Note: The natural deterministic PDA for L gives this DA.

Myhill-Nerode (MN) relations for a language

- An **MN relation** for a language L on an alphabet A is an equivalence relation R on A^* satisfying
 - ① R is right-invariant (i.e. $xRy \implies xaRya$ for each $a \in A$.)
 - ② R refines (or “respects”) L (i.e. $xRy \implies x, y \in L$ or $x, y \notin L$).

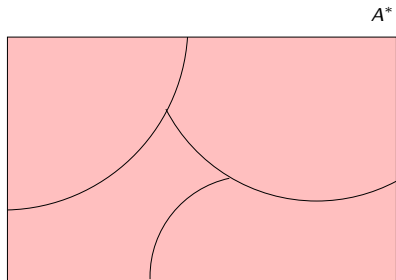

Deterministic Automata for L and MN relations for L

DA for L and MN relations for L are in 1-1 correspondence (they represent each other).

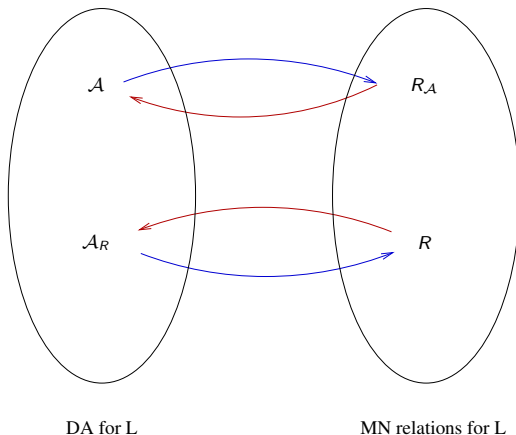

Maps $A \mapsto R_A$ and $A_R \mapsto R$ are inverses of each other.

Example DA and its induced MN relation

L is "Odd number of a 's":

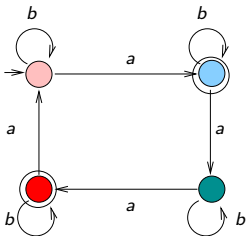

$\mathcal{A} \mapsto R_{\mathcal{A}}$

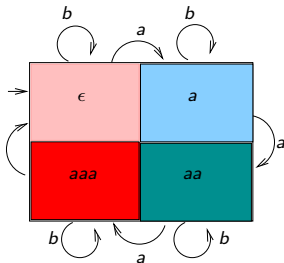
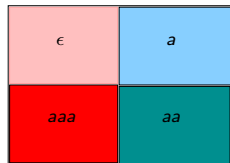

$R \mapsto \mathcal{A}_R$

Deterministic Automata for L and MN relations for L

DA (with no unreachable states) for L and MN relations for L are in 1-1 correspondence.

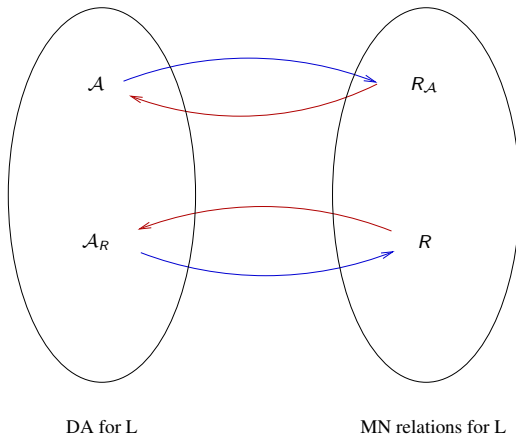

Maps $A \mapsto R_A$ and $A_R \mapsto R$ are inverses of each other.

Any MN-relation for L refines the relation \equiv_L

Lemma

Let L be any language over an alphabet A . Let R be any MN-relation for L . Then R refines \equiv_L .

Any MN-relation for L refines the relation \equiv_L

Lemma

Let L be any language over an alphabet A . Let R be any MN-relation for L . Then R refines \equiv_L .

Proof: To prove that xRy implies $x \equiv_L y$. Suppose $x \not\equiv_L y$. Then there exists z such that (WLOG) $xz \in L$ and $yz \notin L$. Suppose xRy . Since it's an MN relation for L , it must be right invariant; and hence $xzRyz$. But this contradicts the assumption that R respects L .

Any MN-relation for L refines the relation \equiv_L

Lemma

Let L be any language over an alphabet A . Let R be any MN-relation for L . Then R refines \equiv_L .

Proof: To prove that xRy implies $x \equiv_L y$. Suppose $x \not\equiv_L y$. Then there exists z such that (WLOG) $xz \in L$ and $yz \notin L$. Suppose xRy . Since it's an MN relation for L , it must be right invariant; and hence $xzRyz$. But this contradicts the assumption that R respects L .

As a corollary we have:

Theorem (Myhill-Nerode)

L is regular iff \equiv_L is of finite index (that is has a finite number of equivalence classes).

Canonical DA for L

- We call \mathcal{A}_{\equiv_L} the “canonical” DA for L .
- In what sense is \mathcal{A}_{\equiv_L} canonical?
 - Every other DA for L is a **refinement** of \mathcal{A}_{\equiv_L} .
 - \mathcal{A} is a refinement of \mathcal{B} if there is a **stable partitioning** \sim of \mathcal{A} such that quotient of \mathcal{A} under \sim (written \mathcal{A}/\sim) is isomorphic to \mathcal{B} .
 - Stable partitioning of $\mathcal{A} = (Q, s, \delta, F)$ is an equivalence relation \sim on Q such that:
 - $p \sim q$ implies $\delta(p, a) \sim \delta(q, a)$.
 - If $p \sim q$ and $p \in F$, then $q \in F$ also.
 - Note that if \sim is a stable partitioning of \mathcal{A} , then \mathcal{A}/\sim accepts the same language as \mathcal{A} .

Example: 1

A stable partitioning shown by pink and light pink classes, and below, the quotiented automaton:

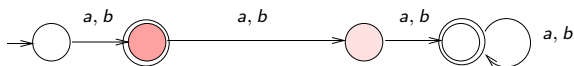
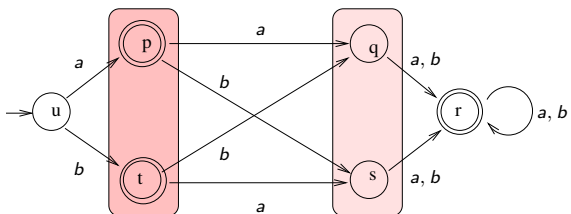

Example: 2

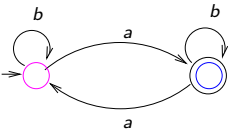
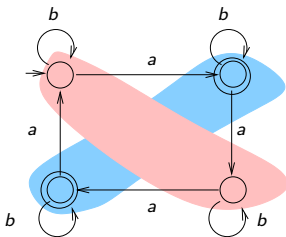

Proving canonicity of \mathcal{A}_{\equiv_L}

Let \mathcal{A} be a DA for L with no unreachable states. Then \mathcal{A}_{\equiv_L} represents a stable partitioning of \mathcal{A} . (Use the refinement of \equiv_L by the MN relation $R_{\mathcal{A}}$.)

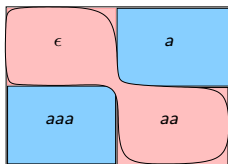
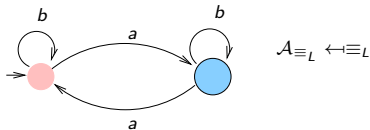
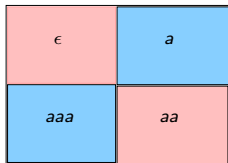
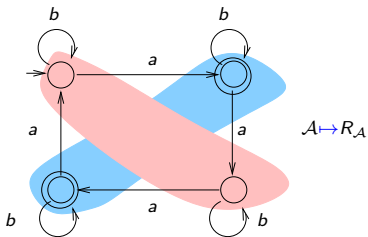

Stable partitioning \approx

- Let $\mathcal{A} = (Q, s, \delta, F)$ be a DA for L with no unreach. states.
- The canonical MN relation for L (i.e. \equiv_L) induces a “coarsest” stable partitioning \approx_L of \mathcal{A} given by

$$p \approx_L q \quad \text{iff} \quad \exists x, y \in A^* \text{ such that } \widehat{\delta}(s, x) = p \text{ and } \widehat{\delta}(s, y) = q, \\ \text{with } x \equiv_L y.$$

- Define a stable partitioning \approx of \mathcal{A} by

$$p \approx q \quad \text{iff} \quad \forall z \in A^* : \widehat{\delta}(p, z) \in F \quad \text{iff} \quad \widehat{\delta}(q, z) \in F.$$

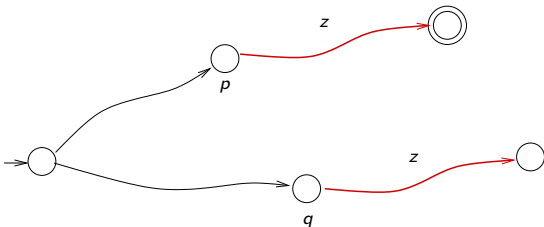

Example of \approx partitioning relation

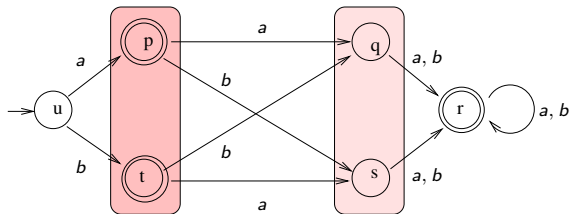

Stable partitioning \approx is coarsest

Claim: \approx coincides with \approx_L .

$\approx_L = \approx$.

Proof:

$p \not\approx q$ iff $\exists x, y, z : \widehat{\delta}(s, x) = p, \widehat{\delta}(s, y) = q,$ and
 $\widehat{\delta}(p, z) \in F$ but $\widehat{\delta}(q, z) \notin F.$
 iff $p \not\approx_L q.$

Algorithm to compute \approx for a given DFA

Input: DFA $\mathcal{A} = (Q, s, \delta, F)$.

Output: \approx for \mathcal{A} .

- 1 Initialize entry for each pair in table to “unmarked”.
- 2 Mark (p, q) if $p \in F$ and $q \notin F$ or vice-versa.
- 3 Scan table entries and repeat till no more marks can be added:
 - 1 If there exists unmarked (p, q) with $a \in A$ such that $\delta(p, a)$ and $\delta(q, a)$ are marked, then mark (p, q) .
- 4 Return \approx as: $p \approx q$ iff (p, q) is left unmarked in table.

Example

Run minimization algorithm on DFA below:

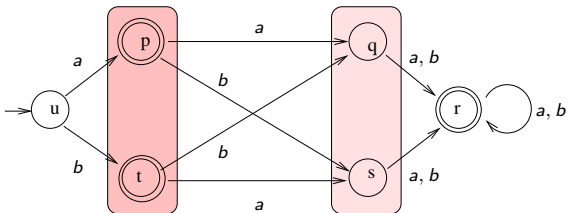

	u	p	t	q	s	r
u	.					
p		.				
t			.			
q				.		
s					.	
r						.

Example

Run minimization algorithm on DFA below:

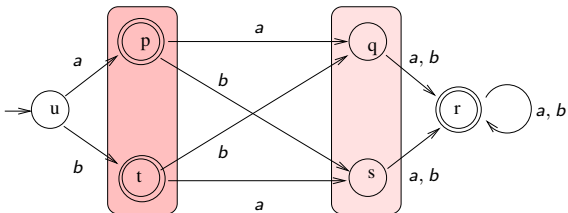

	u	p	t	q	s	r
u	.					
p	✓	.				
t	✓		.			
q		✓	✓	.		
s		✓	✓		.	
r	✓			✓	✓	.

Example

Run minimization algorithm on DFA below:

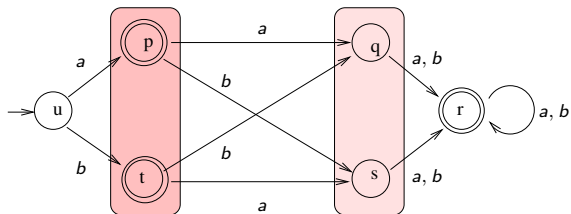

	u	p	t	q	s	r
u	.					
p	✓	.				
t	✓		.			
q		✓	✓	.		
s		✓	✓		.	
r	✓	✓	✓	✓	✓	.

Example

Run minimization algorithm on DFA below:

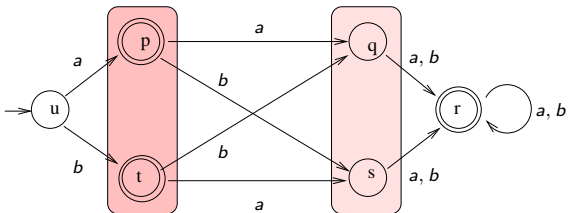

	u	p	t	q	s	r
u	.					
p	✓	.				
t	✓		.			
q	✓	✓	✓	.		
s	✓	✓	✓		.	
r	✓	✓	✓	✓	✓	.

Correctness of minimization algorithm

Claim: Algo always terminates.

- $n(n-1)/2$ table entries in each scan, and at most $n(n-1)/2$ scans.
- In fact, number of scans in algo is $\leq n$, where $n = |Q|$.
 - ① Consider modified step 3.1 in which mark check is done wrt the table at the **end of previous scan**.
 - ② Argue that at end of i -th scan algo computes \approx_i , where

$$p \approx_i q \text{ iff } \forall w \in A^* \text{ with } |w| \leq i : \widehat{\delta}(p, w) \in F \text{ iff } \widehat{\delta}(q, w) \in F.$$
 - ③ Observe that \approx_{i+1} strictly refines \approx_i , unless the algo terminates after scan $i+1$. So modified algo does at most n scans.
 - ④ Both versions mark the same set of pairs. Also if modified algo marks a pair, original algo has already marked it.

Correctness of minimization algorithm

Claim: Algo marks (p, q) iff $p \not\sim q$.

- (\Rightarrow)
- (\Leftarrow)

